



CREATING
VALUES
FLAT FILM AND
SHEET LINES

Extruder



SmartSheets®





In 1959, **Werner Battenfeld** took over the extrusion facilities in Siegburg and integrated them into his worldwide operating company. The brand “Battenfeld” was worldwide known and famous for injection machines, extruders and textile machines.

The first General Manager of the Battenfeld extrusion site was **Walter Kuhne**, who continued to develop the extrusion technology for Battenfeld. By end of the sixties, the fast growth of the group led to serious

Already in the year 1956, **sheet lines** for the production of PC have been delivered – also first tests with PE-sheets have been realized. In the **thermoforming business**, still young at that time, first machines were sold **in the sixties for the production of PS and PVC.**

In the **seventies**, KUHNE GmbH developed for example **the first coextrusion-line** for milk and stripes film, where up to four extruder produced different colours side by side into one blown film.

An additional milestone for KUHNE was reached by placing **HDPE-extrusion-lines** in the market **in the eighties.** More than 500 of these lines were sold. In the same period, a significant amount of **PS- and PP-Inline-machines** were sold to dairies and their suppliers. In the sheet sector, the first huge lines with working widths up to six meter and thicknesses up to 50mm were developed, sold and delivered.

The nineties for KUHNE were dominated by huge coextrusion blown

film lines as well as the ongoing development regarding **multi-layer feedblock systems for flat film and sheet lines.** Outputs were raised and layer thicknesses more and more reduced; in the same time tolerances minimized.

From the year 2000 onwards, the number of delivered blown film lines and machines for five and seven layer has been rising. In Flat film extrusion, KUHNE presented the High Speed concept – a system that almost doubled outputs. Another highlight in sheet extrusion have been numerous **lines for the production of tanks for the automotive industry.** The needed tank sheets have been extruded, welded and used in the cars of worldwide known producers.

From 1949 until today, thousands of KUHNE lines and machines are running all over the world – still rising constantly. Innovations that will change the world of packaging significantly are systematically developed.

Kuhne Maschinenbau GmbH

More than 60 years of experience

The **extruder development of KUHNE GmbH goes far back to the year 1949.** Out of the disorders from the second world war, resulted the first approach to design and build a machine, able to melt plastic. An old drilling machine was used to for the prototype of the extruder by putting a cylinder on top instead of a standard tool. The extruder screw was driven by the drive of the tool, the heating was – already then – realized by heating bands. Resulting from this were the first, pure extruders, mainly for profiles and tubes out of PVC, but **from 1952 onwards also the first lines for sheet- and blown-film.**

financial problems, giving Walter Kuhne the chance to use a Management Buy Out in order to get possession of the Battenfeld extrusion facilities and to rename the company into KUHNE GmbH.

In the following years, KUHNE GmbH concentrated on the **production of blown-film and flat-film; as well as sheet-lines. One of the first blown-film lines was already built in the early fifties**, so that approximately twenty blown film lines per year were delivered worldwide – all with the name and brand of Battenfeld, but designed and built by the future KUHNE staff.

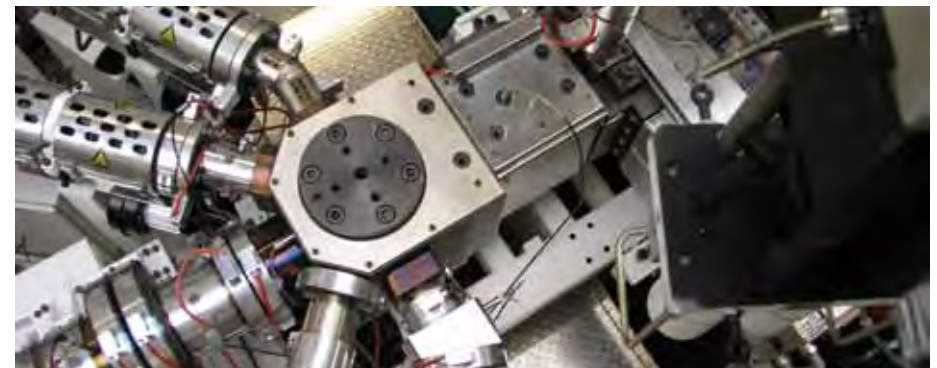

1934

Foundation of the mechanics company Heinrich Koch

1949

Development of the first extruder HKS 80/60

1970

Dipl.-Ing. Walter Kuhne takes over the whole company Battenfeld Siegburg

1972

Construction of the first line for the production of sheets out of high-molecular HD-PE and PP

1975

KUHNE GmbH moves from Siegburg to the new production site in Sankt Augustin

1980

KUHNE supplies Turnkey-ready factories including extrusion

80s and 90s

Delivery of numerous Inline Coextrusionlines (up to 7-layer) – mainly within Europe

1990

KUHNE supplies flat-film line for the production of geo-membranes (6.300mm width) to South America

1997

KUHNE presents the first aluminium-composite-sheet line

Construction of the first 8-layer feedblock (bolt design)

2002

Presentation of the High-Speed-Extruders KHS 60 and 70

2004

Presentation of the first PMMA-sheet line for the production of displays

2011

KUHNE supplies a coextrusion twin-screw-line for the production of PET-sheet without pre-drying and PE-inline-lamination

Delivery of the 50st KUHNE-Extruder with Torque-(Direct-)drive

2012

KUHNE Maschinenbau receives order for a 7500 mm wide Extrusionline for the production of geomembrane films for Northern Africa

Delivery and successful installation of 9-layer lamella-bolt-feedblock

2013

Delivery and installation of the line for Northern Africa.

Another line sold for the production of geomembrane sheet – this time 8000 mm width – for Saudi Arabia

Delivery and installation of the 7th PET-twin-screw-extrusion-line, the 6th PET-extrusion-line in collaboration with EREMA and the 1st PET-line with MRS-extrusion

Highlights



Our Divisions: Flat-Film and Sheet-Lines

Modern Packaging – ecologically compatible

Packaging out of plastic is a decisive contribution to environment protection:

- Protection for packed goods; minimized losses of for example food through transport and storage
- Light weight, energy savings during transport, no energy required by empties transport
- Low energy effort for the production
- Saving of drinking water, as the cleaning and rinsing procedures required in multi-way-systems are not necessary
- Suitable for chemical, material and thermal recycling

Many different, state-of-the-art applications in flat-film and sheet are produced on KUHNE-extrusion-lines:

- Food packaging/barrier foils (margarine, drink cups, yoghurt cups, meal trays, microwave trays...) MAP, FFS
- Medical packaging (barrier foils)
- Stationary foils (folders, index foils etc.)
- Collapsible box, display foils and sheets
- Fibre-reinforced laminated foils, insulating films and tarpaulins
- Smooth or embossed foils and sheets for automotive application
- Optical application
- Sanitary application
- Advertising industry
- Chemical apparatus



Flat Films

Sheets

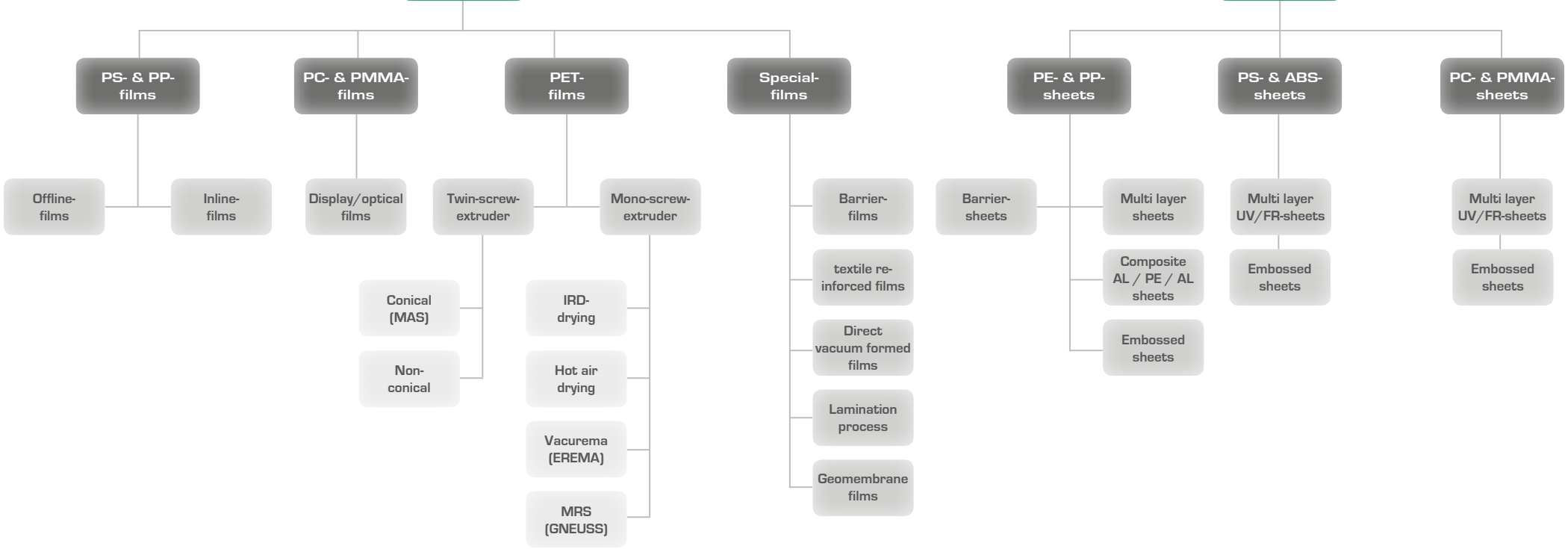

Focusing

We are always focusing on highest efficiency, low energy costs and highest flexibility.

- Customer specific requirements can be realized
- Extruders are available in our lab – trials with customer raw material possible anytime
- Feeding and Dosing, Screen changers, melt pumps and winders of different types and suppliers can be integrated

Flat Films

PS- & PP-
films

Offline-
films

Thermoforming Lines – Components of flat film

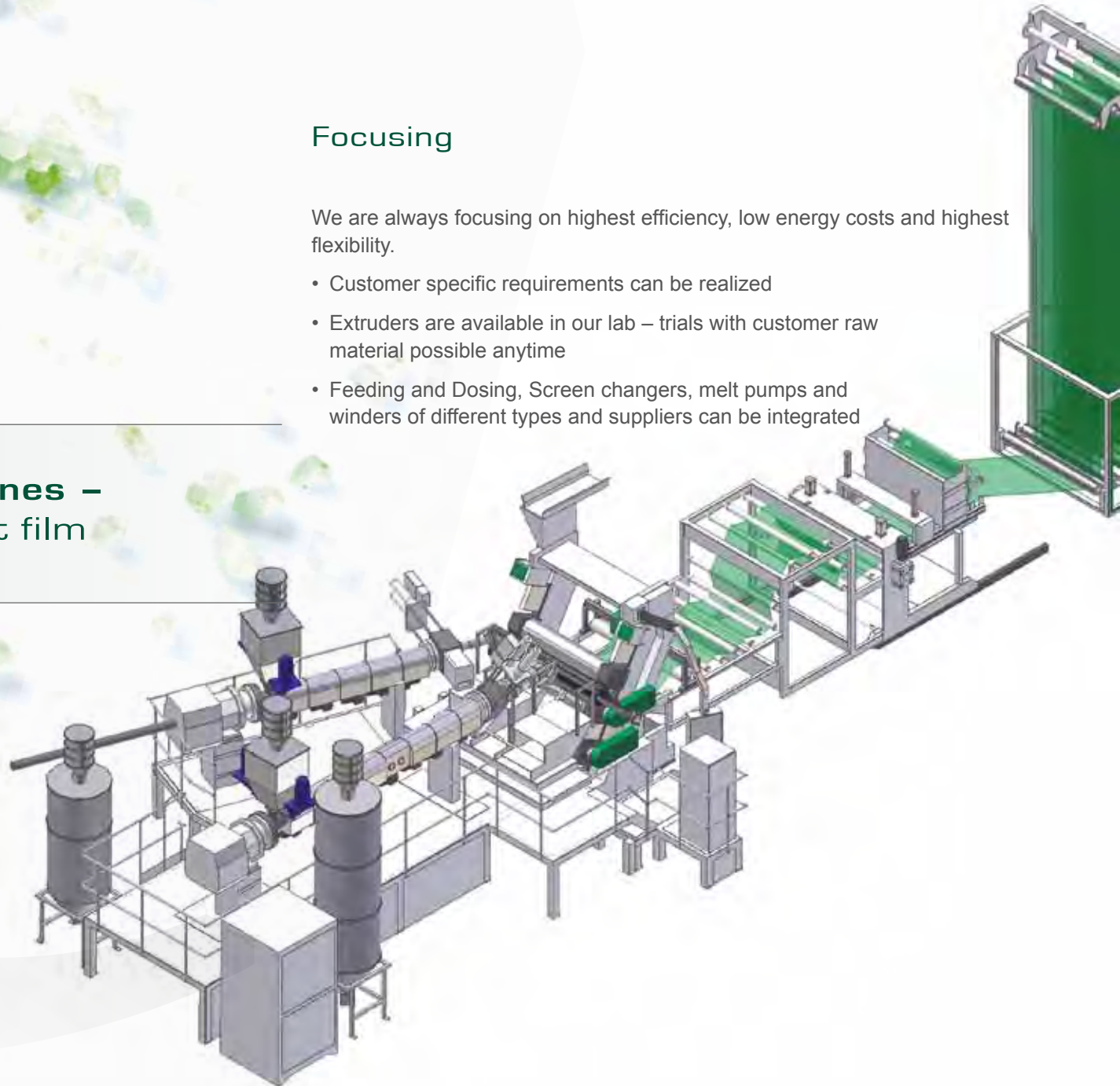

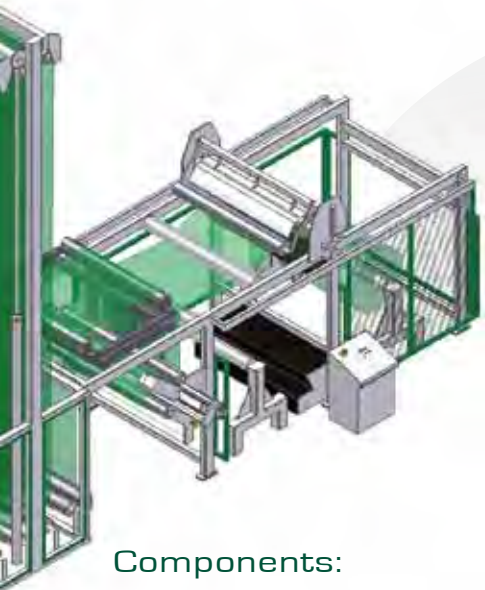

Components:

- Dosing device (on top of the extruder)
- Extruder (with venting)
- Screen changer
- Melt pump
- Static mixer
- Feed-Block-System, Bolts and Lamella
- Flat Film Die
- Roll stack
- Roller conveyor
- Thickness measurement
- Inspection system (Foil Surface inspection)
- Edge cut
- Haul Off
- Accumulator
- Multiple station Winder – partially or fully automatic



High-Speed-Extrusion Line KHS70EE-33D



- P = 440 kW @
- ns1 = 1.000 min-1
- ns2 = 1.500 min-1
- V max. = 5,65 m/s
- PPL max. = 2.200 kg/h PS
1.800 kg/h PP

Flat Films

PS- & PP-
films

Inline-
films

Sustainable concepts – high customer profit

The Inline principle stands for economic manufacturing and production

The Inline process is getting more and more interesting and economical. Up to now, the separate units are linked but with PLC interfaces it's possible to merge them to an installation operational and manageable from the resin to the ready product.

Depending on the lot size inline running is a real alternative compared to the offline process.

It's possible to run the line either according to the thermoforming machine to be the master towards the extruder or reverse - depending to the photoelectric loop control. Linked with the KUHNE-PLC, interface allows starting the line with only one operator.



For the sustainable benefit of the customer the aim is to link extrusion, thermoforming, buffering and even printing. Here the important part is the editing and visualization of actual values and operating of all machine parts.

KUHNE developed its easy running concept with roughly all noted suppliers of thermoforming machines.

Due to the use of the KUHNE-High-Speed-Extrusion-Technology and a special arrangement of the extrusion and thermoforming machine, it is now possible to quadruple the throughput per square meter of floor space requirement.

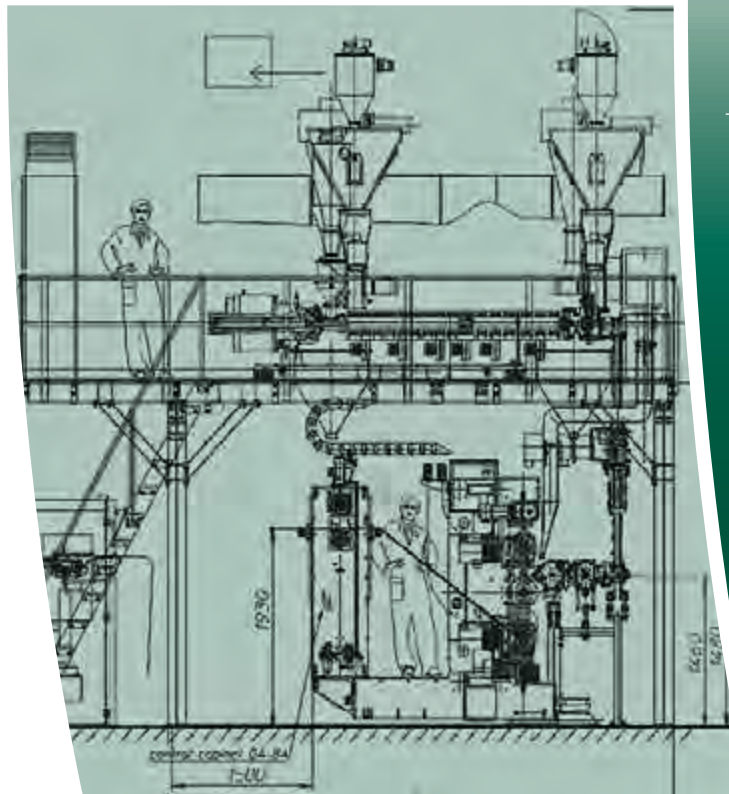

High-Speed-Extrusions lines KHS60EE-36D KS45-24D GA3-900 Inline



- Synchron-Torque-drive
- P = 110 kW @
- nS1 = 450 min-1
- nS2 = 600 min-1
- Ø 60 mm
- V max. = 1,88 m/s
- PPL max. = 500 kg/h PP / 600 kg/h PS
- 4 times less space required compared to standard lines

Plat Films
PET-
films

PET-concepts



PET-films have numerous advantages; for example high tear resistance, chemical, mechanical and thermal stability as well as transparency.

In addition to that, it is possible to directly transform PET In-house / Bottle Flakes or Post-Consumer materials into PET-Flat Films.

Economic efficiency and sustainability have raised the share of films with high percentage of regrind in the last years.

KUHNE-Smart-Sheets offers the possibility of In-line-Lamination PET-PE directly in the roll stack or with a laminator integrated in the line.



You have PET – KUHNE
has your solution:



- Output: 750 kg/h – 2.500 kg/h
- Width: 1.000 mm – 2.000 mm
- Thickness: 120 µm – 1.5 mm
- FDA & EFSA-conformity
- EREMA Vacurema
- GNEUSS MRS-principle
- Twin-screw-extruder
LEISTRITZ
MAS
- KUHNE mono-screw-extruder
with hot air pre-drying
with IRD-drying

Flat Films
Special-films

KUHNE-specialfilms

Direct vacuum forming films (dimpled sheet)

- Foundation wall protection
- Planted, green flat roof sealing
- Engineering, building and tunnel construction

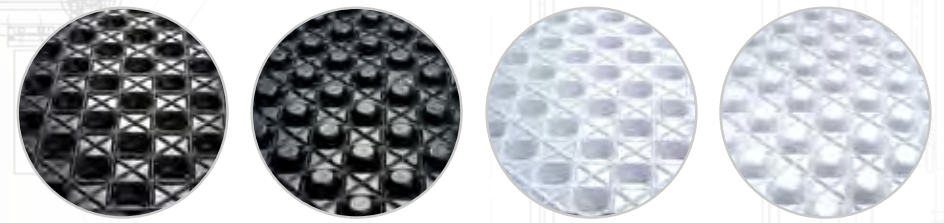

Fabric reinforced films (up to 5 m width without weld seam)

- Flat roof sealing
- Advertising banner
- Decorative scaffolding cladding
- Conveyor belts



Geomembrane films

Geomembrane films are enduring, durable plastic sealing webs with smooth or embossed surface.

Typical for this kind of film is the very high resistance towards chemicals and other, various foreign matters.

The UV stabilized film is 100 % environmentally sustainable and has no negative effects on drinking water.

Applications:

- As isolation or sealing of areas and surfaces at the construction of landfills, chemical storage places, gasoline stations, parking lots etc., in order to prevent pollutions of ground water
- At the construction of lakes, as film for ponds and swimming pools
- As plant and/or root barrier
- Applications in almost all construction and building sites

The most important requirements on geomembrane film is the endurance against movements in the soil and sinkage – in the same time preservation of perfect leakproofness. The applications for such films are getting more and more numerous: Industrial waste dumps, storage of chemicals, water tanks, canals and dikes, but also irrigation ponds or for the production of raw materials such as copper and more.



Geomembrane Lines



- Output from 1.000 kg/h up to 3.500 kg/h
- Width: 5 m, 6 m, 7 m, 8 m (net width)
- Thickness: from 0,5 mm up to 3 mm



Sheets

Sheet extrusion – from thin to thick – from transparent to high-barrier

Sheet lines for the processing of thermoplastics such as:

- PE – HD polyethylene
- PP polypropylene
- SB polystyrol high-impact
- ABS acrylonitrile-butadiene-styrene
- PMMA polymethyl methacrylate
- PC polycarbonate

Mono- or multi-layer by means of Coextrusion, smooth or embossed. Width range from 600 mm up to 4.000 mm. Thickness range from 0,3 mm up to 50 mm; depending on application and raw material.

- One over the other roller conveyors
- Post cooling calibration roller conveyor
- Thickness measurement
- Corona Treatment
- Lengthwise cutting done as:
 - knife cutting system
 - saw
 - mill
- Edge cutting recycling system in different versions
- Protection film lamination; one or both sides
- Haul Offs
- Cross cutting devices such as:
 - guillotine (also in combination with mill or saw)
 - saw
 - mill
- Stacker
 - gantry robot
- Machine parts can partially be fitted into clean room surrounding



Challenge us:



Extruded sheets out of thermoplastics:

- up to 50 mm thickness
- up to 4.000 mm width
- up to 9 layers

KUHNE single screw extruders are efficient, economical and reliable plastification units, proven to handle almost all currently available thermoplastics. They are part of KUHNE turn key extrusion lines such as blown films lines, flat film and sheet lines, cast lines, profile lines, cable coating, recycling and compounding lines. There are more fields of application for KUHNE-extruders in other extrusion domains.

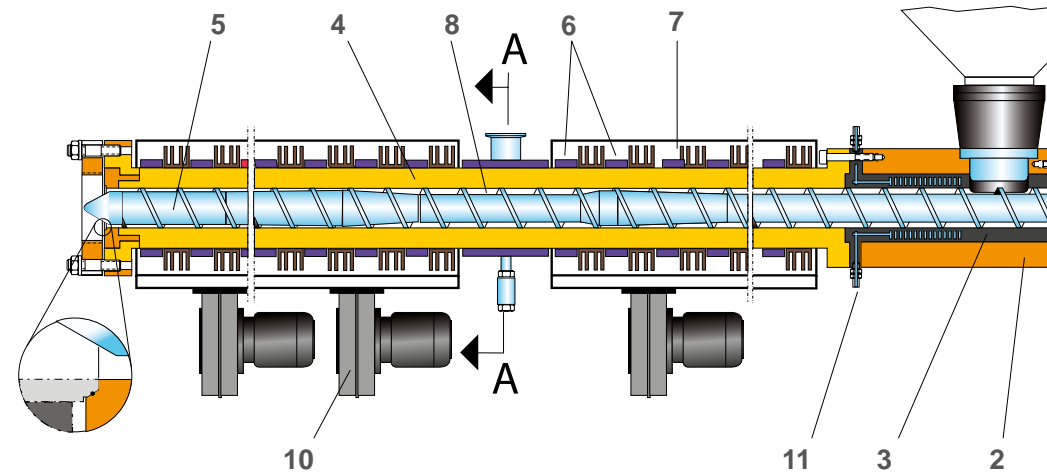

Extruder – It's all about the optimum geometry

All thermoplastics such as granulate, powder or regrind can be processed: for example all known polyolefins, ABS, Polyurethane, TPE, PET, PP, PS, HIPS, PA, EVOH, PU, LDPE, HDPE, filler containing compounds such as PP with wood filler, recycled plastic, biodegradable polymers and high-temperature materials.

- Single Screw Extruders, KS (standard extruders), KLE (low emission), KHS (High-Speed), KFA (Food application)
- Screw diameter 25 – 250 mm, barrel length 24 – 44 D (with venting)
- K45 & K60 as modular principle with shortest delivery times
- High Speed Extruder K45, K60 & K70
- Complete housing as option; L<80 dB(A)
- Available up to 450 °C for high temperature materials

- 3-zone-screws, vented screws, barrier screws with shearing and mixing section
- Barrier-screws for the processing of polyolefins without the need to change the screw
- Vented-screws (for hygroscopic polymers)
- Screw removal either from the front or back of the machine
- More than 60 years of experience on extrusion and screw design
- Barrels with double venting available
- Barrels are gas nitrated, bimetallic liner (optional), with heat separation and grooved feed section, water- or oil-cooled.
- Smooth or grooved feed section
- Output up to 3.500 kg/h
- Temperature controlled feed sections
- Visualization via display, central or decentralized placement of control cabinet
- Low maintenance A.C., D.C., direct drive with gear, torque drive without gear

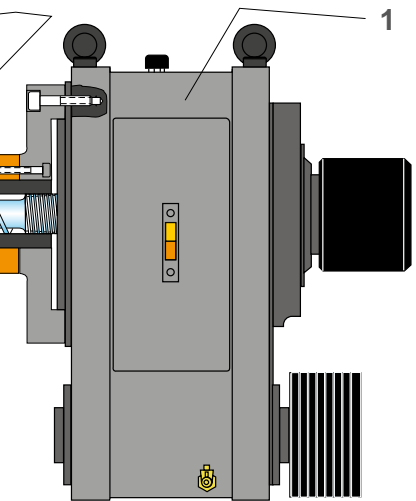

Extruder

- 1 Gear with special hollow-shaft design
- 2 Barrel feed housing
- 3 Exchangeable feed section (smooth or grooved)
- 4 Barrel
- 5 Screw
- 6 Ceramic heater band
- 7 Cooling segment
- 8 Venting dome(s)
- 9 Vacuum unit
- 10 Cooling blower
- 11 Connection for heating and cooling units

Extruder K25 – K250

Barrel and screw design

Latest state of the art designs of barrels and screws guarantee highest output rates with homogenous melt at the same time. Each KUHNE-extruder screw is tailor-made and gets its individual geometry according to application and material. In order to achieve maximum life, nitride-hardened, armoured or special alloy screws are used.

Barrel

The extruder barrel – comprising barrel feed housing (2), exchangeable liners (3) and barrel feed section – is equipped with ceramic heater bands (6) plus cooling segments for high capacity cooling. The barrel length is 24, 30, 33 or 36D;

vented extruders 33, 39 or even 44D. The feed section with feed housing (2) and the exchangeable liner (3) are a separate, modular part.

Screw removal

A special hollow shaft design allows the screw to be removed either to the rear or to the front. Removal of screw to the rear is recommended to avoid time consuming removal of downstream equipment.

Vented extruders

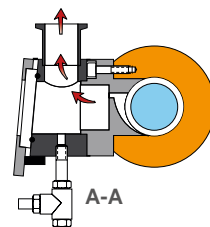

All extruders of the “E” series have a generously sized vented zone (8). Large quantities of moisture and monomers are separated and eliminated ecofriendly with low maintenance running vacuum pumps.

Drive and gear

The low noise solid gear of low noise transmits the torque to the screw via V-belt drive between motor and gear to ensure the optimum adaptation to the screw speed. Today, KUHNE-extruders are more and more equipped with A.C. drives with inverters or permanent torque drives with highest energy efficiency.



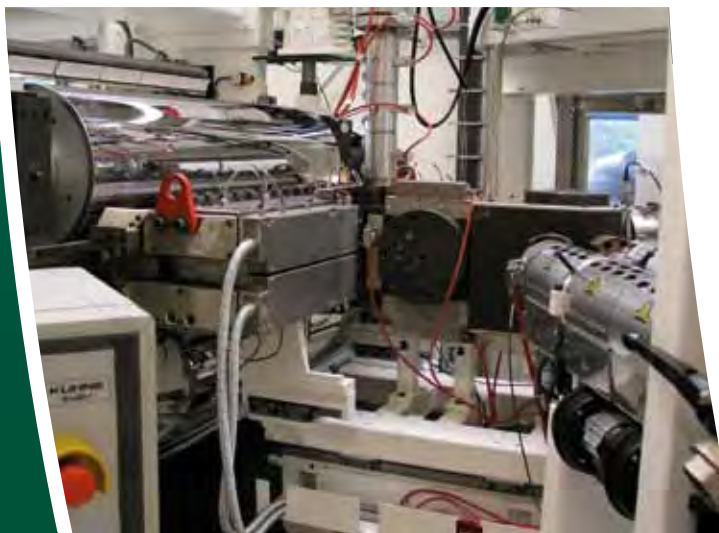
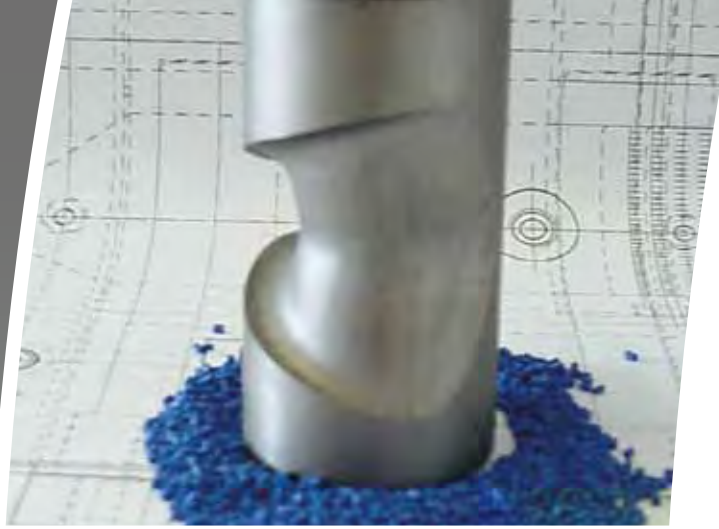

K-Tool is a daughter company of KUHNE Group

The company K-Tool is producing screws, barrels, feed bushes, feed blocks and dies (flat and round dies).

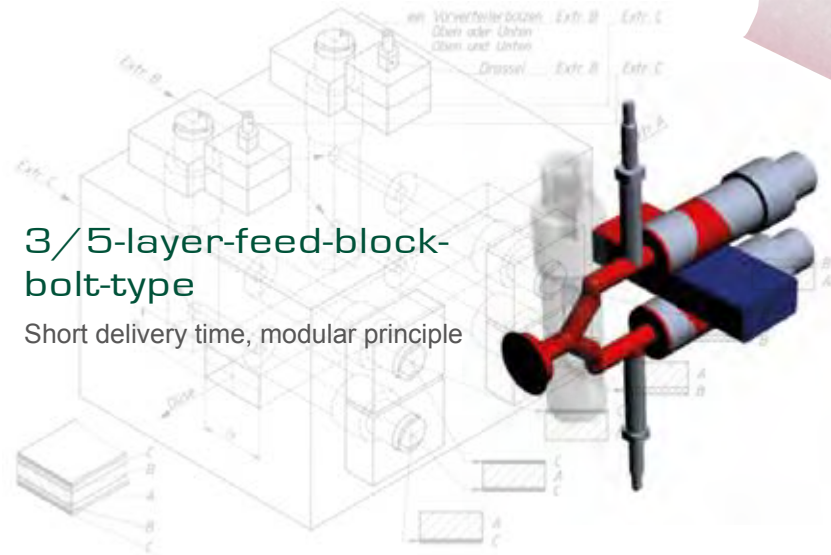

3/5-layer-feed-block-bolt-type

Short delivery time, modular principle

7-layer-feed-block-lamella-type

Thin middle layer (EVOH), edge capsulation, short residence time

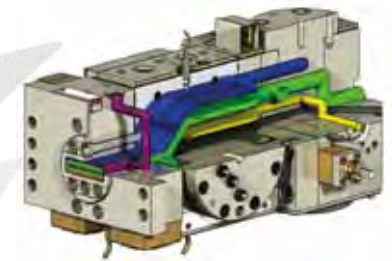

9/11-layer-feed-block-combined lamella/bolt-type

Flat dies

- Optimized rectangular feeding zone for feed-block coextrusion
- Optimized flow channel because of 3D-based design, with or without restrictor bar
- Restrictor bar to optimize the melt flow
- Changeable flex lips
- Deckling – optional
- Manual or automatic lip gap adjustment
- Flexible lip gap 0,1 mm – 15 mm
- Sheet dies with lip gap 2 mm – 75 mm
- Fast gap:
Width range from 100 mm – 6.000 mm



K-Tool GmbH
Einsteinstraße 20
D-53757 Sankt Augustin/Germany
phone +49(0) 2241 23427-0
fax +49(0) 2241 23427-200
www.ktool.eu



KUHNE roll stacks

The roll stack is the decisive element for a high-quality surface of the films.

An optimized tempering of the rolls in combination with the special hardened KUBI-rolls allows the both-sided polishing of films even below 0,3 mm. According to application request, the roll stack can be executed vertically, horizontal or 30° inclined. Air knife integration instead of // in addition to the rolls for thin films.

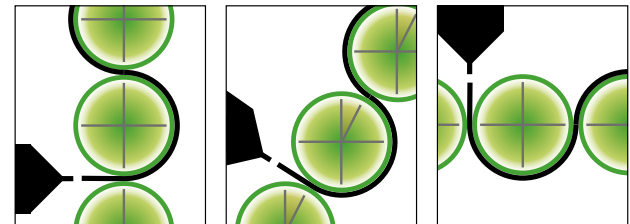

Vertical for PS, PP, HDPE, ABS
 30° – 45° inclined for PMMA, PC, PET- Movable-systems for top and lower roller
 Horizontal for PMMA, PC, PET

KUHNE High-class surfaces

- Width range from 600 to 10.000 mm
- Roller diameter from 200 to 1.000 mm
- Rollers individually driven
- Servo- and A.C.-drives for roll stack and haul off
- Individually cooled rollers with water or oil
- Adjustment of roll gap and roll positioning on both sides by servo drive
- Pressure optimized bending roll
- Fast opening for quick roll change
- Movable top or bottom roll
- Air knife
- Hardened KUBI-rolls, high precision rolls and thin wall rolls optionally, thin wall rollers
- Production of thin films from 0,1 mm thickness on
- Chill-roll-principle
- Easy integration

Automation – KEC Kuhne Extrusion Control

Processdata management based on SIEMENS(S7-SPS)-Industrial-PC-system.

All production lines can be equipped with KEC-process control/visualization.



- Visualization of all relevant process parameters; nominal and actual values
- Alarm system
- Recipe storage and management
- Control of the heating zones for different types of the die
- Storage and archiving
- Tracing, trends and curve charts
- Printouts and protocols
- Maintenance and service via teleservice/diagnosis
- Multiple language switch
- Visualization of process parameters of machine components of other suppliers



Data
management
KEC





Our service – your benefit



KUHNE SERVICE

Service at KUHNE Group offers his customers best possible solutions in the fields of spare parts, retrofitting, maintenance, trouble shooting – as well as start ups and trainings. Therefore, highly motivated and competent service engineers are at your direct and personal disposal.

Tool service

- Exchange and cleaning of tools directly at your line
- Checking and expertise of all line components on the spot
- Complete cleaning of dies and blown film heads at K-Tool; followed up by reprocessing for improved product quality

Repair service

- Repair of screws, barrels, blown film heads and dies at K-Tool
- Repair of all installed and used components by the manufacturer

Spare part service

- Supply of original spare parts
- Dispatch of the needed parts on the same day with your order before noon

Trouble shooting

- Intervention of our technicians possible within 24 hours
- 24h Hotline
- Long distance diagnosis via Teleservice

New trends and developments

- Continuous new technical developments and improvements by our technical staff and R&D engineers
- Such as: chrome platings, coatings, fuels and lubricants etc.

Erection and start up of new lines

- Consultation with our customers before delivery in order to optimize the course of erection
- Personal visit of KUHNE technician on the site before delivery possible
- Detailed erection plan and schedule to be sent to customer before delivery
- Start ups and test-runs

Maintenance

- Tailor made maintenance concepts for complete lines or components
- Maintenance contracts; also long-term

Training

- Machine maintenance
- Trouble shooting
- (optimized) operation of lines

Retrofitting

- Modernization of your line for optimization of output, quality and changeover

Advantages for our customers:

- **Personal, direct and skilled care through our experienced contact persons**
- **Multi-language contact persons and service technicians**
- **Higher productivity and value retention through preventive maintenance and upkeep**
- **Use of original spare parts for fast and easy fitting**
- **Reduction of line Stops**
- **Prolongation of operational life span**

phone +49(0) 2241 902 90

fax +49(0) 2241 902 282

mail service@kuhne-group.com

Hotline: 0180 590 20 99 (charged)



CREATING
VALUES
FLAT FILM AND
SHEET LINES

KUHNE GmbH
Einsteinstraße 20
D-53757 Sankt Augustin/Germany
phone +49(0) 2241 902 0
fax +49(0) 2241 902 222
info@kuhne-group.com

www.kuhne-group.com

