

# FROZEN MEAT CUTTERS

CUTTING TO THE OPTIMUM SIZE FOR EFFICIENT FURTHER PROCESSING

G 530  
G 740

GS 510  
GFS 620

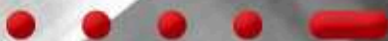

## APPLICATIONS OF THE LASKA FROZEN MEAT CUTTERS

LASKA frozen meat cutters are highly regarded for their cutting performance and low energy consumption. LASKA customers use frozen meat cutters for the following products:

- › **Meat**
- › **Fat**
- › **Fish**
- › **Vegetables**
- › **Fruit**
- › **And much more ...**

### STRENGTHS AND BENEFITS

LASKA frozen meat cutters process frozen meat and other frozen food of a temperature down to -25 °C. The infinitely variable lifting height of the cutting bar of the guillotine ensures the highest possible cutting performance of the machine due to customized adaptation to the product size. Applying comparatively low force, the LASKA frozen meat cutters are very gentle on the material. This also has a beneficial effect on the machine, which is not strained needlessly, thus ensuring it becomes a long-term partner and an attractive investment.

### QUALITY PROVEN IN USE

Just like all other LASKA machines, the frozen meat cutters are made of solid stainless materials. They meet strict hygienic requirements and are easy to clean. The design allows for harsh operating conditions and provides easy and safe operation as well as good access for servicing.



**DESIGN**

- Compact and space-saving design with integrated control box
- Long service life and proven cost benefits
- Height adjustable machine feet
- Attractive, elegant design
- Closed base plate for silent operation

**PRODUCTION**

- Gentle cutting of frozen meat blocks
- High output
- No loss of quality caused by poor block handling
- Continuous feeding for higher performance
- Loading arm / loading platform also suitable as unpacking area
- Processing even of larger and spherical frozen meat blocks

## LASKA FROZEN MEAT CUTTERS

### YOUR BENEFITS AT A GLANCE

**SERVICE AND MAINTENANCE**

- Minimum maintenance required due to proven, field-tested machine concept
- Easily accessible inspection doors
- Worldwide service network and competent local support on all continents

**OPERATION**

- Easy handling and user-friendly, robust operating elements
- Push-button control and/or control panel with finger touch control panel and plain text display
- Adjustable cutting size and infinitely variable cutting height in case of guillotines

**ELECTRICAL EQUIPMENT**

- Low current consumption due to optimized drive and control technology
- Built-in control box for longer service life

**HYGIENE AND SAFETY**

- Closed base plate prevents contamination and dust in the interior
- Polished surfaces for the highest possible hygienic standard
- Safety devices for optimum working safety





## MACHINE TYPES

### THE VERSATILE LASKA PRODUCT RANGE



#### FEATURES OF GUILLOTINE-TYPE FROZEN MEAT CUTTERS G 530 / G 740

- › For frozen meat blocks up to a max. cross section of 520 x 300 mm (G 530) and/or 700 x 400 mm (G 740)
- › High hourly rate and short cutting time due to infinitely variable lifting height of the knife bar
- › Continuous loading results in higher performance
- › Robust machine with long-term cost benefits



#### FEATURES OF FROZEN MEAT CUTTERS WITH CUTTING DRUMS GS 510 / GFS 620

- › For frozen meat blocks up to a max. cross section of 500 x 300 mm (GS 510) and/or 600 x 380 mm (GFS 620)
- › High hourly rate due to continuous loading and powerful drive
- › Drive designed for very heavy duty application
- › Robust machine with long-term cost benefits



#### APPLICATION OF GUILLOTINE-TYPE FROZEN MEAT CUTTERS G 530 / G 740

- › Gentle processing of the material to be cut (especially for raw sausage)
- › Processing temperature down to -25 °C
- › Cutting size adjustable from 27 to 64 mm
- › Smaller pieces possible due to optional cross-cutting drum
- › Due to a hydraulic block clamping device, round or spherical blocks can be processed perfectly



#### APPLICATION OF FROZEN MEAT CUTTERS WITH CUTTING DRUMS GS 510 / GFS 620

- › Gentle processing of the material to be cut
- › Processing temperature down to -25 °C (GFS 620) and/or -15 °C (GS 510)
- › Cutting size GS 510: 25 mm (bow knives)
- › Cutting size GFS 620: 35 mm (cutting teeth)
- › Due to the double-drum cutting system, round or spherical blocks can be processed perfectly

## EQUIPMENT

### FOR YOUR GUILLOTINE-TYPE FROZEN MEAT CUTTER



#### DRIVE

- › Drive elements in closed machine housing
- › Hydraulic drive
- › Machine can be switched on only with the standard transport trolley being in the right position
- › Low current consumption due to optimized control and drive technology
- › Subdued operating noise

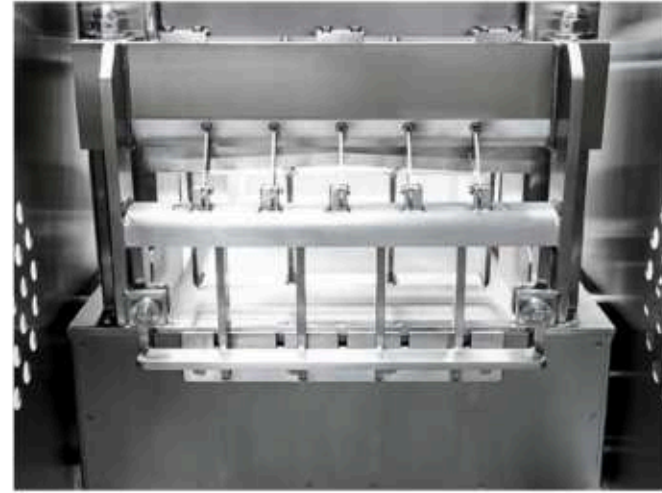

#### CUTTING BAR

- › Hydraulically driven
- › Damped reversing of knife stroke prevents hard impacts and overstraining of the machine
- › Infinitely variable knife stroke adjustable via control panel at the level of the blocks provides for shorter cutting time
- › Exchangeable, two-part guillotine knife
- › Optional cross cutting drum for smaller pieces

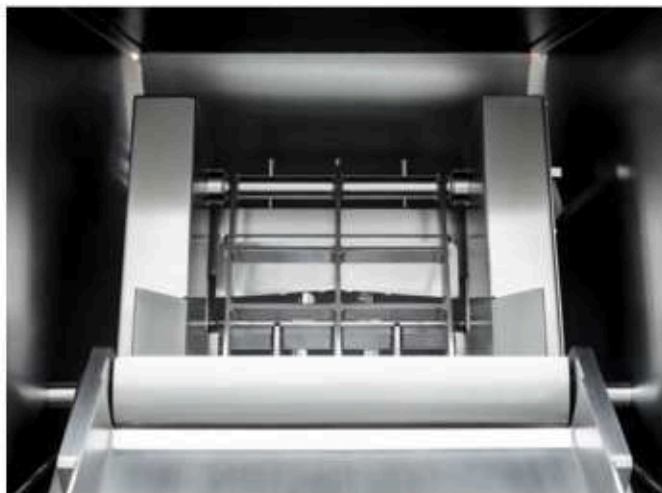

#### BLOCK CLAMPING DEVICE

- › Fixes blocks automatically during the cutting process
- › Prevents escaping of the blocks
- › Special advantage with round, spherical frozen meat blocks
- › Permanent synchronous movement of block clamping device and cutting bar
- › Hydraulically driven



#### ELECTRICAL EQUIPMENT

- › Built-in control box and main motor
- › Robust and powerful unit with motor circuit breaker
- › Programmable logic controller with microprocessors
- › Easy to operate due to clearly arranged control system

## EQUIPMENT

### FOR YOUR FROZEN MEAT CUTTER WITH DRUM KNIVES

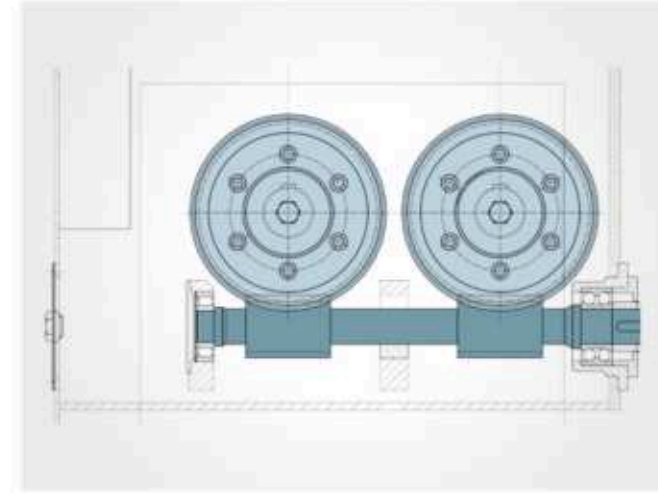

#### DRIVE

- › Worm gear pair in oil bath for very heavy duty
- › Safety devices prevent overloading and reduce damage caused by foreign matter penetrating into the cutting area
- › Drive elements in closed machine housing
- › Machine can be switched on only with the standard transport trolley being in the right position
- › Low current consumption due to optimized control and drive technology



#### DIFFERENCES IN CUTTING DRUM

- › With cutting teeth (GFS 620): Particularly suitable for standardization, for sections approx. 38 (optional 30) x 40 x 80 mm in size
- › With bow knives (GS 510): Particularly suitable for the production of raw sausage to prevent pulling out of sinews and tendons, for palm-sized sections 25 mm in thickness



#### PATENTED CUTTING DRUM

- › Two counter-rotating cutting drum prevent escaping of the blocks
- › Special advantage with round, spherical frozen meat blocks
- › Regrinding of bow knives (GS 510): approx. every 3 years; not necessary with cutting teeth (GFS 620)



#### ELECTRICAL EQUIPMENT

- › Built-in control box and main motor
- › Robust and powerful unit with motor circuit breaker
- › Easy to operate due to clearly arranged control system



## OPTIONS FOR YOUR LASKA FROZEN MEAT CUTTER



### LOADING ROCKER

G 530 standard – GS 510, GFS 620 optional

- › Stainless, hydraulic
- › Easy to operate
- › Also acts as a very convenient unpacking area



### INCLINED BELT CONVEYOR

- › Stainless steel
- › Incl. trip tray and collection pan
- › Side guides on both sides, foldable for cleaning
- › Frame height adjustable +/- 75 mm with 4 lockable castors
- › Auxiliary equipment: sensor control via light barriers for optimum filling



### LOADING PLATFORM

G 740 standard

- › Stainless, hydraulic
- › Easy to operate
- › Horizontal, open platform facilitates placement of frozen meat blocks
- › Also provides a very convenient unpacking area
- › Platform size: 1000 x 820 mm



### METAL DETECTOR

- › To detect metal foreign matter
- › Conveyor belt running forward and backward
- › Visual and acoustic warning signal

## THAT'S WHAT OUR CUSTOMERS SAY ABOUT THEIR LASKA FROZEN MEAT CUTTER



### **DELIKA A/S** DENMARK

„Since 2011 we are producing salami with our LASKA frozen meat cutter and are very satisfied for the following reasons:

The machine is made so strong, that it cuts the meat directly from the freezer at over -20 degrees with no problems. Also the cut of the meat is very nice and we never have problems with the meat block getting stuck in the machine. The lifting device is perfect for the operator and the fact that the operator can load more than one block into the machine saves us a lot of time.

We decided to buy a Laska machine not only because of the significant heavy weight of the machine, but also because of the great reputation LASKA's frozen meat cutters and the company have in Denmark.“

### **MR. HANSEN** OWNER



### **PERUTNINA PTUJ** SLOVENIA

“Food industry is technologically a complex and very demanding industrial branch. Therefore we are taking into account and giving a large importance to the reliability of our partners in the implementation of technological equipment. LASKA is in this regard a constant. We are cooperating with LASKA since 1989 and have with its help built our food concern.

From the very first cutting machine forward, the decision on modernization and implementation of our technological lines has been clear. We will be choosing LASKA. Reliability, high quality, and additional value on the side of our customers are just a few very important reasons for our choice.“

### **MR. GLASER** CHIEF EXECUTIVE OFFICER

## TECHNICAL DATA

### PERFORMANCE LIST

#### PERFORMANCE CHARACTERISTICS

TYPE		GS 510	GFS 620	G 530	G 740
Block cross section (width x length)	mm	500 x 300	600 x 380	520 x 300	700 x 400
Processing temperature	° C	to - 15	to - 20	to - 25	to - 25
Size of pieces / cutting thickness	mm	130 x 80 x 25	80 x 40 x 35	28 - 60	27 - 64
Type of cutting		bow knives	cutting teeth	guillotine	guillotine
Motor rating	KW	18,5	22	5,5	16,5
Fuse	A	63	80	25	50
Supply cable	mm <sup>2</sup> CU	16	25	4	10
Speed	rpm	50	50	–	–
Loading rocker		o	o	•	–
Loading platform		–	–	–	o
Cross cutting drum				o 2 and/or 5 pieces	o 5 pieces
Conveyor belt loading		o	o	o	o
Sensor control (for conveyor belt loading)		o	o	o	o
Metal detector (for conveyor belt loading)		o	o	o	o
Cleaning system (for conveyor belt loading)		o	o	o	o
Infinitely variable rate of feed (for conveyor belt loading)		o	o	o	o

#### CAPTION

•	standard
o	option
–	not available

#### DIMENSIONS AND WEIGHTS

TYPE		GS 510	GFS 620	G 530	G 740
Length mm   X		1580	2020	2400	2700
Width mm   Y		1620	1900	1100	1350
Height mm   Z		2050	2150	1860	2200
Max. height mm   A		2470	2350	2470	–
Weight kg		1360	1500	1000	2600

#### SEAWORTHY CASE\*

Length mm	1930	2330	2550	3020
Width mm	1900	2200	1350	1720
Height mm	1610	1710	2150	2360
Weight kg	260	400	300	420

\* depending on type of transport

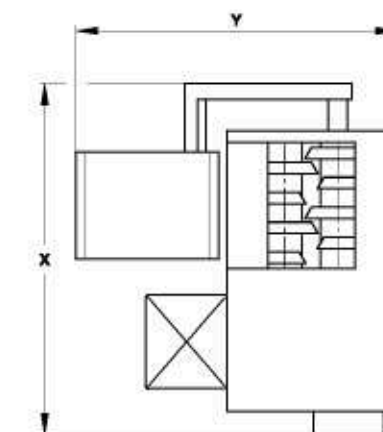
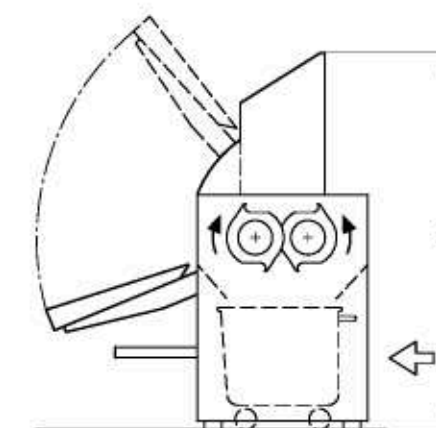
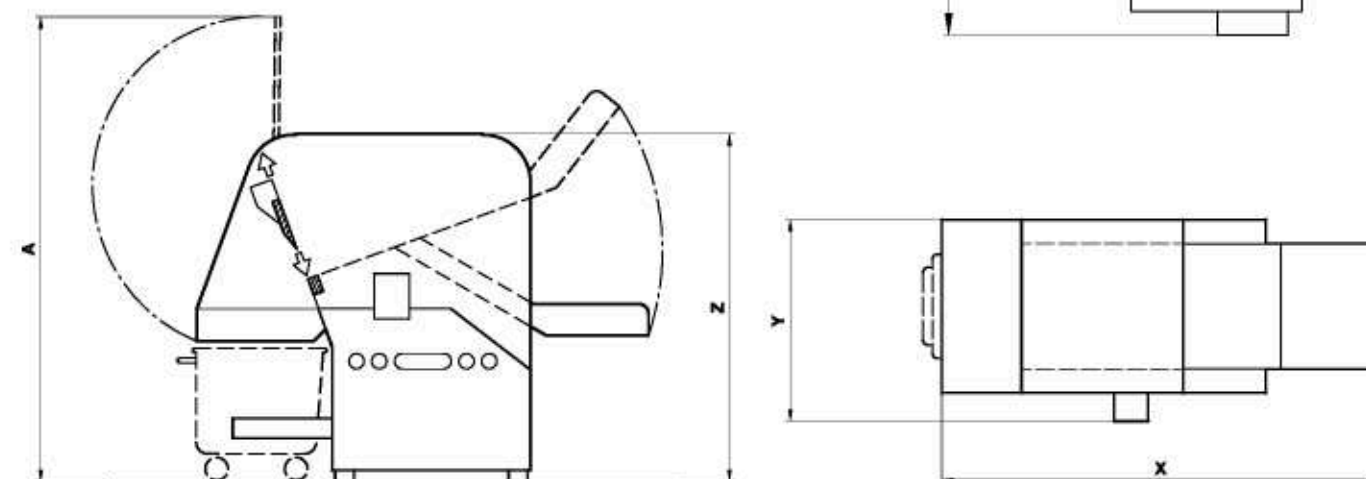



## TRADITION & INNOVATION

MORE THAN 130 YEARS OF EXPERIENCE



Since 1880, the family enterprise has been active as a supplier of the food industry and closely associated with the latter. The machines produced by LASKA are high-grade products made of stainless steel featuring a number of auxiliary equipment.

Although LASKA is generally known for the best processing of meat, there are numerous other applications in practice, such as the processing of grease, cheese, fruit, vegetable, yeast, pasta, sweets, etc.

Today, LASKA machines are famous for their high quality in more than 130 countries on all continents, where they work to the complete satisfaction of national and international customers.

### OUR PRODUCT RANGE:

- Cutters
- Grinders
- Frozen meat cutters
- Emulsifiers
- Mixing machines
- Production lines



**Maschinenfabrik LASKA Gesellschaft m.b.H.**

Makartstraße 60, 4050 Traun – Austria

P +43-7229 / 606-0

F +43-7229 / 606-400

[laska@laska.at](mailto:laska@laska.at)

[www.laska.at](http://www.laska.at)

DEALER/PARTNER

