

Description

Our BS 21 model is a mobile vacuum tray sealing device that you can use to vacuum pack trays made of different materials (PP, CPET, APET and many others) to treat them with gas and to seal them.

Specifications

Maximum sealing area without outline	325 x 265 mm
Maximum sealing area with outline	300 x 210 mm
Maximum foil width	340 mm
Maximum tray height	100 mm
Working cycle	2 per minute
External dimensions	500 x 820 x 1320 mm
Vacuum pump	21 m ³ /h
Weight	125 kg
Compressed air connection	6 bar
Electric connection	1 phases, 230, 50 Hz
Wattage	2,2 kW



Benefits



General design:

Our compact BS 21 tray sealing machine is suitable for „work in confined spaces“. The machine is our entry-level model in MAP and inert gas packaging.

When designing it we placed special value on a good price-performance ratio. The powerful BUSCH vacuum pump makes possible rapid evacuation of the vacuum chamber.



Sealing frames:







The sealing area is suitable for trays up to a size of 325 x 265 mm (without outline cutting). The clean outline cutting of the foils guarantees an attractive piece of sales packaging. Transport of the foil is assured by the pushing in of the drawer.



Controller:

Important process parameters (vacuum, gas, sealing time) can be stored in 5 programming slots. The sealing temperature can be set according to the type of foil.

Division of the sealing plate as an example

	without outline cutting	with outline cutting
single use	 325 x 265	 300 x 210
double use	 260 x 160	 210 x 148
triple use	 260 x 100	 80 x 210
fourfold use	 125 x 160	-

Information about the table of uses:

- All sizes are stated in millimetres
- The uses structure can be confirmed after inspecting the tray pattern
- Other uses are available on request

Technical drawing

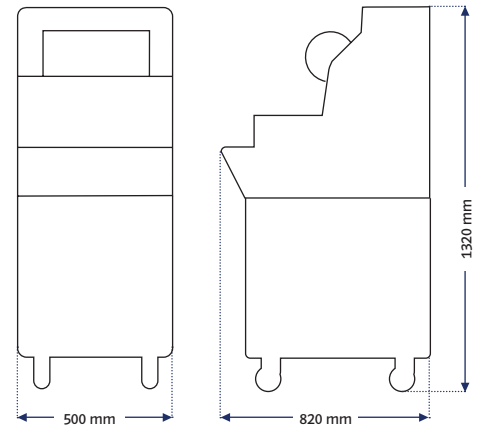

Product features



General details

- Semiautomatic vacuum packaging in airtight trays
- Robust stainless steel construction, mobile and ready-to-connect unit
- Splash-proof components
- Easy maintenance
- Highperformance vacuum pump, insertion plates for level adjustment



Sealing

- Automatic outline cutting
- Compressed air support for a firm sealing result
- Teflon-coated surface
- Easy changing of foil and tools



Control

- Programmable sensor control with 5 memory locations
- Precise vacuum and gas sensor
- Vacuum, gas and sealing time adjustable



Options

- Machine in oxygen version
- Soft, sound-absorbed compressor
- We have a great variety of sealing frames in stock
- Sealing frames in special sizes upon request