

Cutters for the industry
... only from MADO!

50 Years
Innovation
1960 - 2010



Meat processing
machines

State-of-the-art technology for modern meat processing.

The new INDUSTRIAL CUTTERS from MADDO, the specialist for hygienic and economic meat processing machines save time and money and make for outstanding results while cutting first-class products. All of them are designed for the professional meat producers' various requirements. An absolutely sophisticated technology combined with innovative machine control ensures the best working results with all products to be processed.

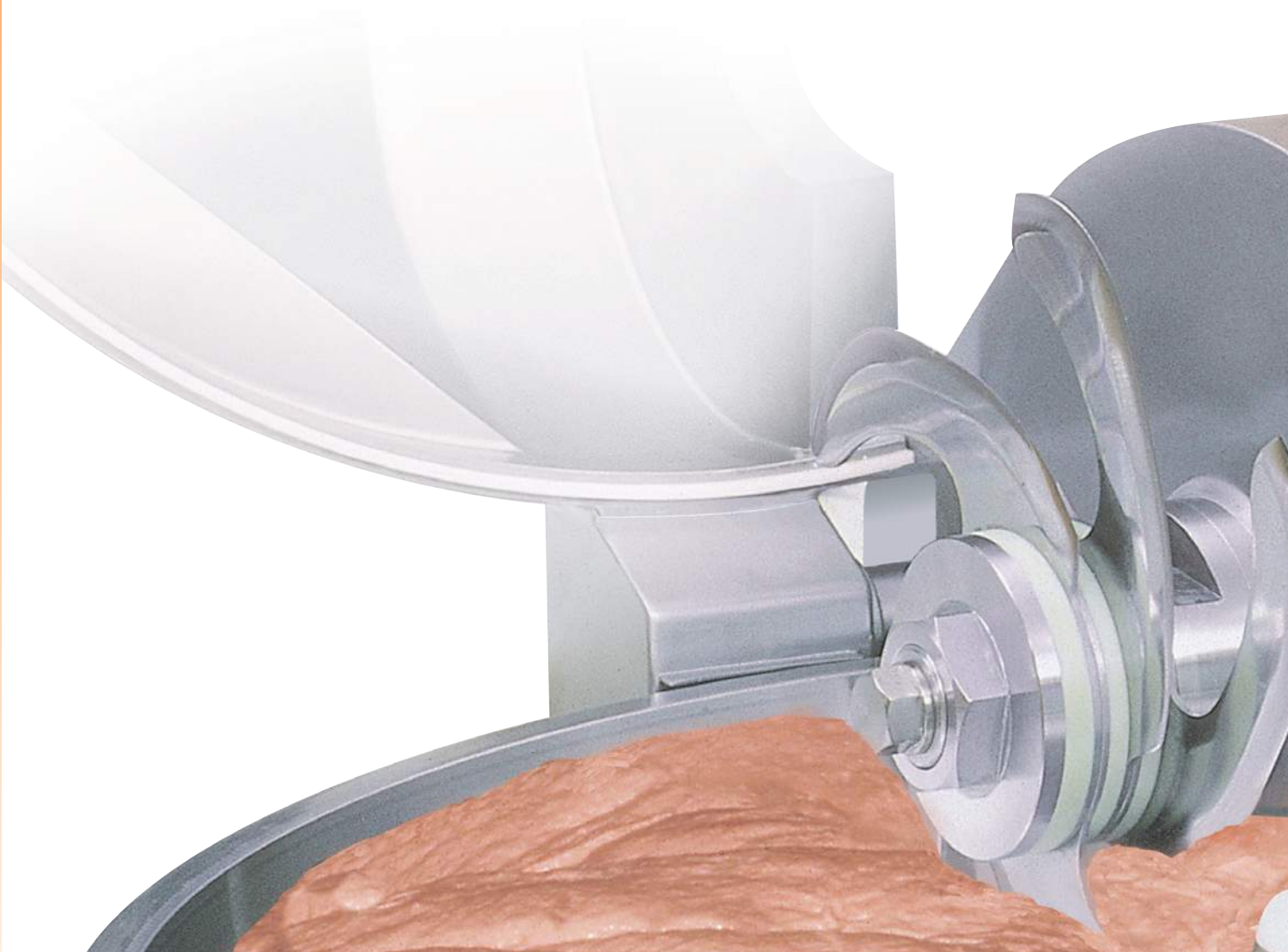

Quality that you can trust. The new INDUSTRIAL CUTTERS with 220 litres contents produced by MADDO are absolute top-quality products. If you are looking for high-quality as well as economic production results, easy cleaning, a high standard of hygiene or longevity, there is no need for you to look any further as MADDO cutters are definitely up to the food industry's high requirements and therefore every user will find the solution he is looking for.

Naturally, the MADDO product range corresponds to the EC machine guidelines for safety and hygiene No. 2006/42/EC. MADDO maintains a quality management system and is certified in accordance with the ISO standard DIN 9001. This means safety for our customers.

- Cutter with 220 litres bowl contents
- Vacuum device, gassing unit, cooking and cooling device
- Up-to-date design. Ergonomically designed according to latest scientific knowledge
- Continuous drive
- Smooth surfaces – high hygienic standards, easy to clean
- Self-supporting "stainless steel" machine housing



INDUSTRIAL CUTTERS 220 and 220 VA innovative cutter technology for the modern meat industry.



INDUSTRIAL CUTTER MSM 769 SL

The INDUSTRIAL CUTTERS 220 and 220 VA are a “must” for the quality-orientated meat producer. In these machines the MADDO hygiene construction has been realized exemplarily. The very sturdy machine housing, made exclusively of “stainless steel” and the ergonomic design of the operating elements have become the benchmark in modern meat processing. If you take boiled sausage or raw sausage, through the cutting hood’s special geometry all the products are made in outstanding quality. The new MADDO INDUSTRIAL CUTTERS made for efficient work – thus saving time and costs.

- Quality improvement
- Increasing efficiency
- Hygiene improvement
- Cost saving



INDUSTRIAL CUTTER 220 VA with
vacuum device. For highest requirements in
terms of productivity and performance.

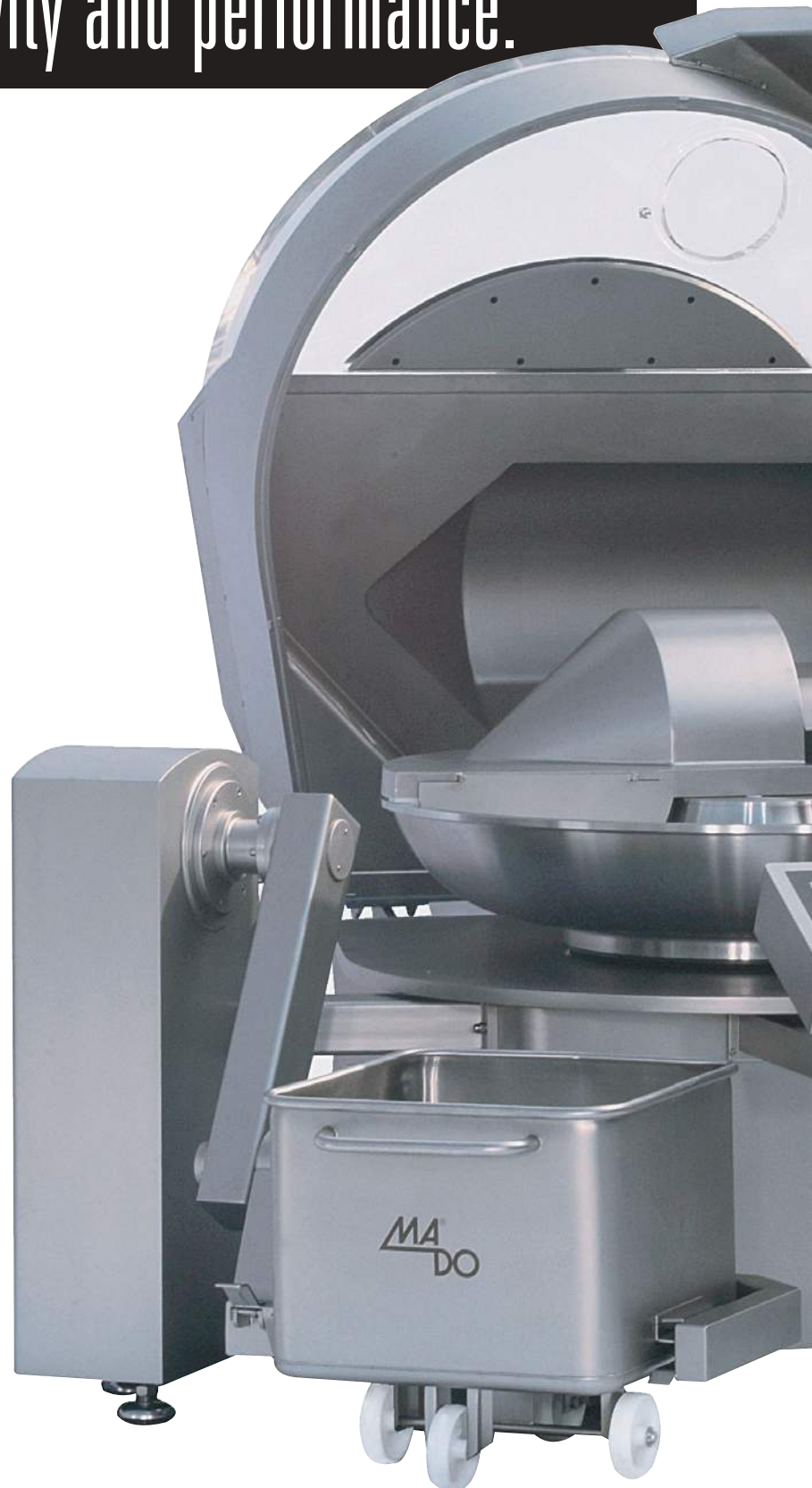

The INDUSTRIAL CUTTER 220 VA is the ideal solution if you wish to cut under a vacuum. By means of the high-performance vacuum pump the air can escape fast off the processed product. By applying the technique of cutting under the vacuum the protein's disintegration is improved. In so doing, a higher filling can be achieved when the boiled sausage is produced. The oxydation of oxygen is avoided despite nitrite reduction. The result is a very compact product that can be preserved for a definitely longer time.

With the INDUSTRIAL CUTTER 220 VA the processes of loading and unloading are done very quickly that you only have to move the noise reduction lid.

- Quality improvement
- Increasing efficiency
- Hygiene improvement
- Cost saving



INDUSTRIAL CUTTER MSM 769 VA

INDUSTRIAL CUTTER 220 VA.

Optional devices for boiling, cooling and aerating.

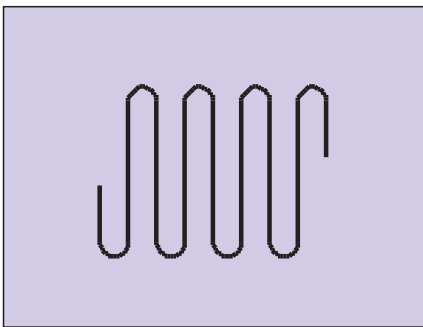

Cooking

For the production of boiling sausage roasts and pies the INDUSTRIAL CUTTER 220 VA can be equipped with a cooking and cooling device, if desired. If the product is minced, boiled or cooked and cooled within one working step, no precious proteins and flavouring agents are lost. By producing within one work step the handling of the material and the cleaning effort are reduced considerably.

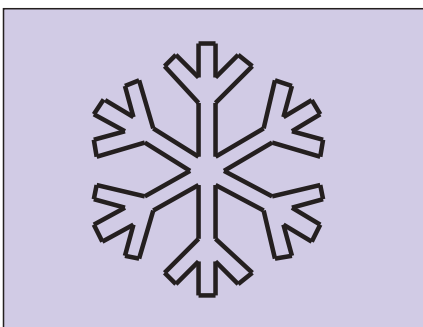

Cooling

In order to optimize the cooling procedure or for the purpose of pre-frosting the INDUSTRIAL CUTTER 220 VA can be equipped with a device for inserting liquid gas, if desired. In this case the superfluous cooling medium is discharged via a fixed tube system equipped with a shut-off flap.

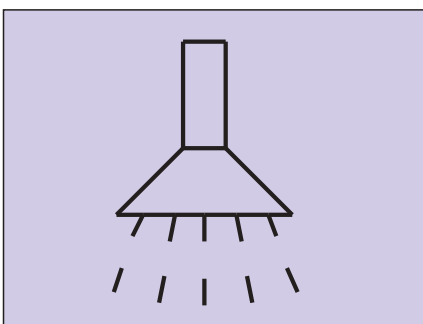

State-of-the-art Technology

In order to improve the taste and optimize the product's colour you can equippe the INDUSTRIAL CUTTER 220 VA with an aeration device.

MADO INDUSTRIAL CUTTERS

220 and 220 VA.

Designs and details.

Continuously variable driving concept

It is standard for all MADO INDUSTRIAL CUTTERS to be equipped with a frequency converter drive for the knife shaft and bowl. This is how we ensure that the drives start and stop smoothly. There is no over-operation of the power supply system as the frequency converters donot allow this to happen. The INDUSTRIAL CUTTERS 220 and 220 VA dispose of 15 preprogrammed steps respectively for the cutting and mixing procedures as well as 3 pre-programmed bowl speeds. In the mixing mode the knives can be turned backwards as well. It goes without saying that the preprogrammed revolutions per minute can be adapted to the client's requirements.



Knife heads

The INDUSTRIAL CUTTERS 220 and 220 VA can be operated with the knife heads 4, 6, or 8, whatever you like best for your specific application. Knife head 6 with step-like cutter knives is the standard equipment.



Balancing device

Impeccably balanced knives have to be used so that the machine runs without any vibrations. As an option an electronic balancing device can be chosen for an optimized balance of the knife head. With this device the control system is integrated into the cutter's panel.

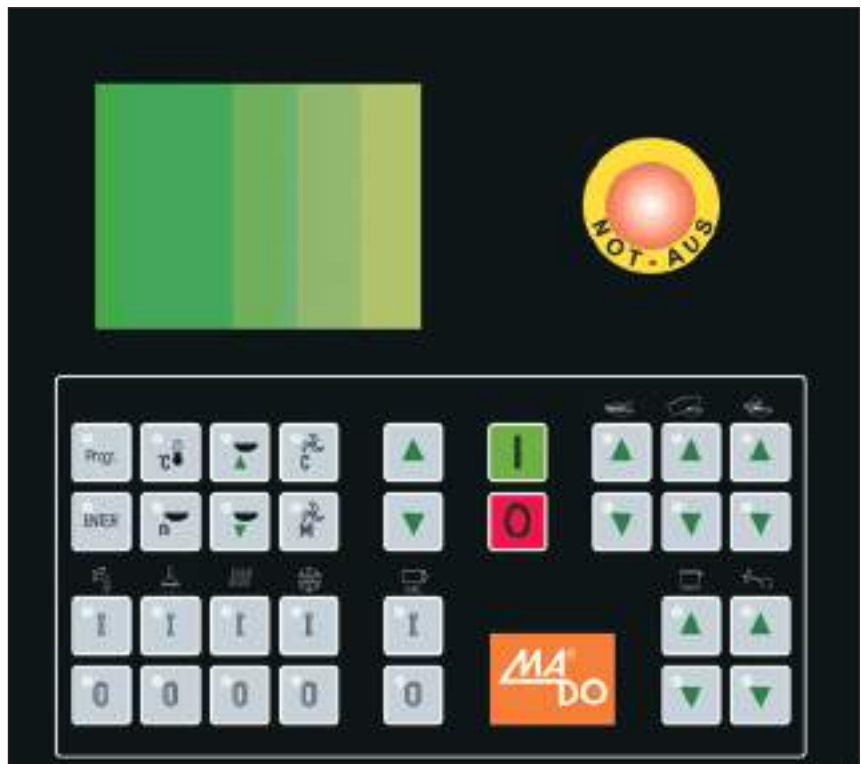

Ergonomic and easy-to-clean panel

The large-area panel with a water-tight plastic film on the keyboard and large-area LCD display allows an easy operation of the cutter. Operation errors are virtually non-existent as there is one separate key for each function.

State-of-the-art technology

The INDUSTRIAL CUTTERS 220 and 220 VA are extremely compact and you can feel hardly any vibrations due to their self-supporting housing design made completely of “stainless steel”. The sturdy cutting hood made of 16mm strong stainless steel protects from cut-throughs in the case of potential knife breaks and increases the noise absorption. The highest requirements in terms of smooth running and noise emission are met. The machine is delivered in a “plug-in” state. Through the modern design of the drive and the electrical equipment there is no need for a separate service cabinet. All of the functional components are integrated into the machine casing.

MADO hygiene construction

The whole machine housing including the supporting parts within the trimming are completely made of “stainless steel” with the INDUSTRIAL CUTTERS 220 and 220 VA. As the housing construction is round and completely closed and has smooth surfaces you can easily clean it and, in so doing, meets the highest hygiene requirements.

**INDUSTRIAL CUTTER MSM 769 SL
with emptying and loading device**

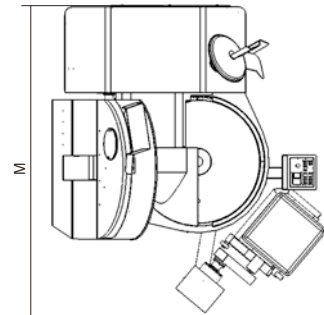
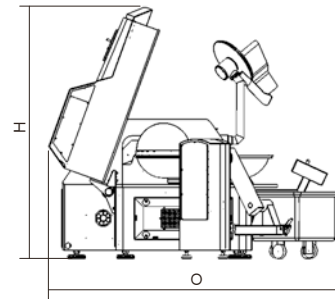
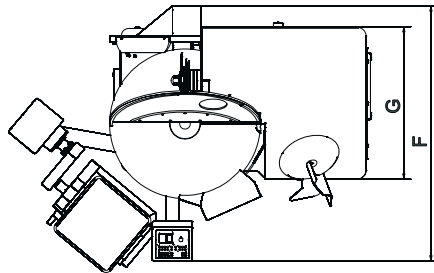
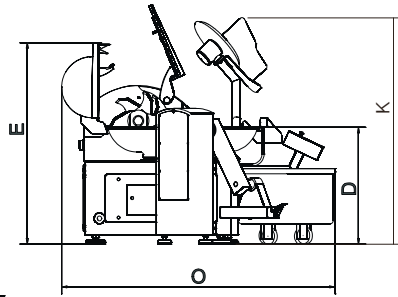
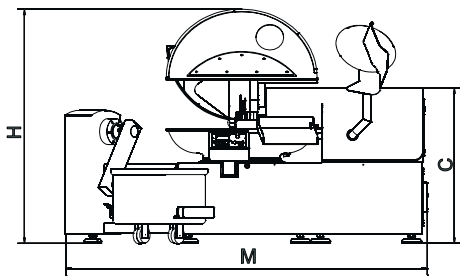

**INDUSTRIAL CUTTER
MSM 769 VA
with vacuum device**

Type	MSM 769 SL	MSM 769 VA
A	-	-
B	-	-
C	1462 mm	1462 mm
D	1080 mm	1080 mm
E	1856 mm	-
F	2423 mm	2910 mm
G	1447 mm	2000 mm
H	2205 mm	2630 mm
K	2028 mm	2285 mm
L	-	-
M	3220 mm	3400 mm
N	-	-
O	2532 mm	3011 mm
Bowl- Ø	Ø 1420 mm	Ø 1420 mm
Wall distance	500 mm	500 mm
Current type	400 V, 50 Hz	400 V, 50 Hz
Nominal capacity	135 kW	135 kW
Fuse protection	250 A inert	250 A inert
Knife head	6er	6er
Knife shaft revolution/cut	500-5000 U/min	500-5000 U/min
Mixing forwards or backwards	50-500 U/min	50-500 U/min
Bowl revolutions per minute	8-20 U/min	8-20 U/min
Bowl capacity	ca. 220 litres	ca.220 litres
Weight	4200 kg	5000 kg



- Meat grinders
- Bowl choppers



- Band saws
- Knife sharpeners

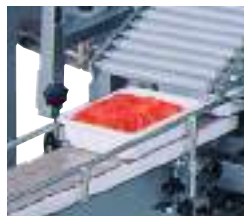

- Mixers
- Portioning systems
- Industrial machines



MADO machines comply with the EC Machine Norms. They are marked with the CE sign. MADO is certified according to DIN ISO 9001.



Special voltages on enquiry. Technical changes made during the course of further development are reserved.



MADO special machines for modern meat processing at qualified specialists.

MADO GmbH
 Balmerstraße 10
 D-72175 Dornhan/Schwarzwald
 Telefon +49 (0) 74 55 93 1-0
 Telefax +49 (0) 74 55 22 63
<http://www.mado.de>
 E-mail: info@mado.de
 Germany

