



# F-Line

F100/103

F160/163

F190/193

Professional  
vacuum stuffers for  
small production plants  
and the industry

# F-Line F100-F200

## Innovative conveyor technology

### Rotary systems

Frey integrated a generously dimensioned vane cell pump with 14 chambers in the F-Line F100-F200.

With the Peek-Cam-system a new material combination is used which concentrates the wearing out on only one part of the rotor system and ensures a higher service life. The rotor system works with highest portioning exactness and the new geometry of the chambers ensures an optimum sucking in of the filling material. The result is an optimum sausage aspect, also of critical sorts.

In connection with the most modern FREY- control and drive technology the rotor system of F-LINE F100-F200 achieves highest portioning exactness, also by producing high quantities. The maximum portioning speed is abt. 600 portions/minute.

The F-LINE 200 achieves a filling performance of max. 4.800 kg/h and a filling pressure up to 40 bar. The F-Line F200 therefore is the filling stuffer of this series with the highest performance. The machine can universally be used and can also be operated with automatic clipping machines.

New are the models F-Line F103/F163/F193 which can be used for the production with an increased filling pressure e.g. for the fabrication of beef sticks. A particular synchronized gear is used with an increased moment of rotation and a minimal reduced filling performance.

F-LINE F100-F200 manages to do portioning and linking of different types of casings such as natural and artificial casings, tins or as leading pump for attachments.



### Flexibility

is a catchword in our time. The customers of today expect a larger product diversity than in former times. With F-LINE F100-F200 you are well prepared for the future. The FREY vane cell pump guarantees an especially high care for the sausage meat. You can fill all kind of sausages - independent on the sausage meat - e.g. warm and liquid liver sausage, sausage with big meat pieces, tough raw sausage meat at minus degrees, you always get the highest quality of your products.

An easy conversion to fill sausages with big meat pieces is always possible. On special request rotors with fewer wings and as result a larger volume of the chambers are available.

# Clear advantages for F-Line users

Best product quality due to the large dimensions of the FREY meat pump.

Highest hygienic standard, no screws or dirt corners in the direct food area.

Excellent economic efficiency.

High filling power.

Low maintenance costs due to the maintenance-free servo drive.

Fast and easy change of sorts.

Low noise level due to the FREY servo drive.

Low consumption of electricity due to the most modern control engineering.

Easy cleaning of the vacuum system.

Multiple combinations with C-LINE accessories and external devices.



## F-Line F100

### Hopper

F-LINE F100/103 has a divisible hopper of 90 liters.

The divisible hopper facilitates the intermediate cleaning as well as the charging of the hopper with small quantities for often changing the sausage type.

The counter screw can be dismounted, therefore the best hygienic conditions are guaranteed.



# Drive technology of the future

## Servo drive with positioning controller

The servo-drive with positioning controller is trend-setting. This drive unit makes an important higher positioning exactness possible, comparable to the old hydraulically driven systems. It is to be distinguished by a high moment of rotation and a quick reaction. The linking process is concipated extremely dynamically due to a correspondent programming of the drive parameters. Also with a very high working speed the machine cares for the sausages during the linking process. So e.g. the acceleration of the rotor system during the start and stop process can individually be adjusted.

Dependent on the conveyor system the spiral stirrer is driven by a separate computer controlled FU drive. The rotating speed can be ajusted to the product and the filling speed.

Optionally a servo linking motor is available instead of the standard linking motor. The servo linking motor is distinguished by a higher dynamics and a more precise linking. The Servo linker is also used as drive of the grinding head system WK130.

The noise level of the machine is extremely low. Due to the high efficiency F-Line needs less energy. Considering the increasing energy prices a lower consumption of energy becomes more and more important.

This kind of drive unit is especially wear-resistant and maintenance-free as only few mechanical components are installed.

The servo positioning controllers are situated separately and thermally apart in the machine.

Simple and safe connection of all additional appliances at a strike guarded place. The digital drive and communication between the TC filler control and additional appliances with CAN-Bus system ensure processing security.

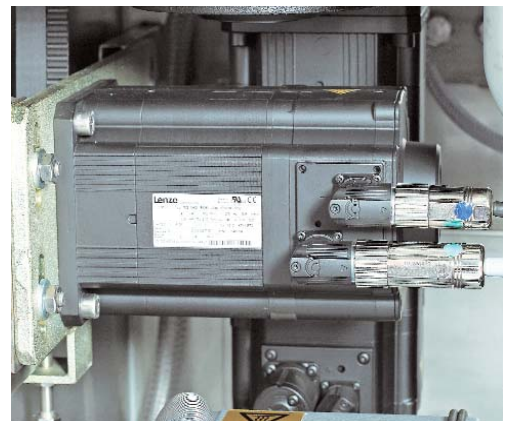
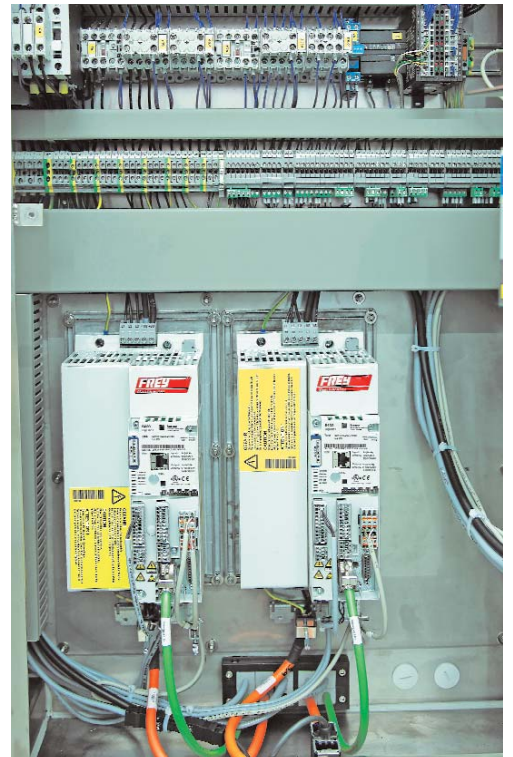

# Convincing ergonomic details

## Cleaning and hygiene

A simple cleaning is the basic requirement for best hygienic conditions in the production. Therefore FREY-stuffers have smooth external contours.

F-Line F100/103, F 160/163, F190/193 and F200 are conforming to the CE-regulations.

The splash and strike guard, which can be taken off, serves as additional protection to avoid damages made by the cleaning personal and pointed tools.

The machine housing is completely made of high-quality stainless steel.

The expenditure for cleaning and maintenance is very low due to the easy disassembling and neat countours between the parts.

## Ergonomic operation

The operating zone has been arranged with a big operating comfort. The vacuum window is situated in the field of vision and in the working zone.

By activating a vacuum valve situated in the cover, the vacuum channel is automatically cleaned.

## Linking gear

F-LINE is equipped with a linking gear without limits for your production. It has especially been developed for the industry and has just proved itself. High-power toothed belts care for a maintenance-free operation. For filling big diameters, you can easily take off the linking gear by means of a quick-closing. Thereby, the way of the sausage meat is shortened and the greasing is minimized.

## Special equipment

F-LINE F100-F200 can flexibly be used, semi fully automatic clipping machines can be adapted.

In connection with the conveyor linking system BAS02 and the automatic hanging line AHL02 the performance of the sausage production can enormously be increased.



# Powerful, practical and conforming to CE - standard

## Target groups of F-Line F100/103-F160/163:

Small to medium-sized production plants.

Productions running half-automatic clipping machines.

Production of sausages.

Suitable for the production of small calibers with high pressure.

Productions with attachments demanding high conveying capacity.

Productions with high demands on the exactness of the portions and the quality.



### Lifting device

F-LINE F160-F200 can be delivered with or without a hydraulic lifting device for norm trolleys. The stirring device, which is controlled by the transporting capacity and the meat guiding in the neck of the hopper ensure a continuous filling of the rotor chambers. A fast emptying of the machine as well as a quick change of sorts is guaranteed.

### Hopper

F-Line F160/163 is delivered with a divisible 160-liters-hopper which is usually charged by means of a lifting and dumping device. For cleaning purposes the foot step can be tilted out. For opening or closing the hopper is assisted by a integrated shock absorber. The contents of the hopper of F190/193/F200 is 250 liters.



# Target groups of F-Line F190/193-F200:

Medium-sized and industrial productions.

Large production of sausages.

Suitable for small calibrated products, which need a high filling pressure.

In connection with BASo2 and AHL02 systems.



Productions with high demands on the exactness of portions and the quality.

Production of raw sausages with the grinding head system WK130.

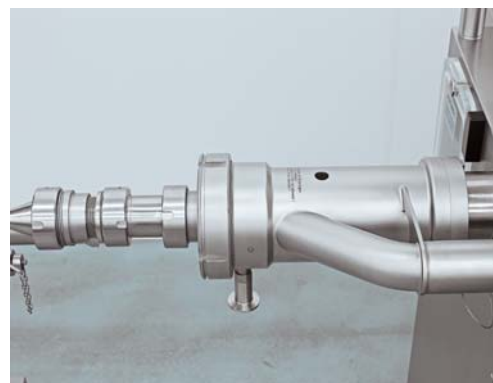
Optimal suitable for all FREY C-Line components.  
See the function survey below.



Function survey

													
		Kampalita 2-30 (CLine system)	F-Line F50	F-Line F60 / F52	F-Line F100 / F103	F-Line F160 / F163	F-Line F190 / F193	F-Line F200	F-Line F222 / F223	F-Line F260	F-Line F286	K-Line K3300	
C-LINE	PM 40	ok	ok	ok	ok	ok	ok	ok	ok	ok	ok	ok	
	PM 75	ok	ok	ok	ok	ok	ok	ok	ok	ok	ok	ok	
	DMFB90	ok	ok	ok	ok	ok	ok	ok	ok	ok	ok	ok	
	DMFB92	ok	ok	ok	ok	ok	ok	ok	ok	ok	ok	ok	
	CL6	ok	ok	ok	ok	ok	ok	ok	ok	ok	ok	ok	
	WK130			SA	SA	SA	SA	SA	SA	SA	SA		
	UTB30/135	ok	ok	ok	ok	ok	ok	ok	ok	ok	ok	ok	
	SE 25		ok	ok	ok	ok	ok	ok	ok	ok	ok	ok	
	PB30/36		ok	ok	ok	ok	ok	ok	ok	ok	ok	ok	
	CLPS300		ok	ok	ok	ok	ok	ok	ok	ok	ok	ok	
	CLPS320		ok	ok	ok	ok	ok	ok	ok	ok	ok	ok	
	CLS300		ok	ok	ok	ok	ok	ok	ok	ok	ok	ok	
	FB30/50	ok	ok	ok	ok	ok	ok	ok	ok	ok	ok	ok	
	PF130	ok	ok	ok	ok	ok	ok	ok	ok	ok	ok	ok	
	BF50 / 70/100		ok	ok	ok	ok	ok	ok	ok	ok	ok	ok	
	FT162		ok	ok	ok	ok	ok	ok	ok	ok	ok	ok	
	DK20 S		ok	ok	ok	ok	ok	ok	ok	ok	ok	ok	
	DK20 F		ok	ok	ok	ok	ok	ok	ok	ok	ok	ok	
	DK40		ok	ok	ok	ok	ok	ok	ok	ok	ok	ok	
	KF150		ok	ok	ok	ok	ok	ok	ok	ok	ok	ok	
UFK	ok	ok	ok	ok	ok	ok	ok	ok	ok	ok	ok		

# IPC control TC 266/733 with touch screen operation



The ultimate stuffer control system with all variety of functions consists of an industrial personal computer and a touch screen panel in the front door of the filling machine.

- solid hardware
- industrial PC with 266 MHz and an ergonomic 8,4" touch screen panel
- interfaces: CF Card, USB, Ethernet 10/100 Mbps
- online connection with your office PC via TCP/IP network connectivity
- powerful software without limits
- logbook for the filling process and errors
- F-Line in connection with TC 266/733 meet the BDE standard of WS Food.

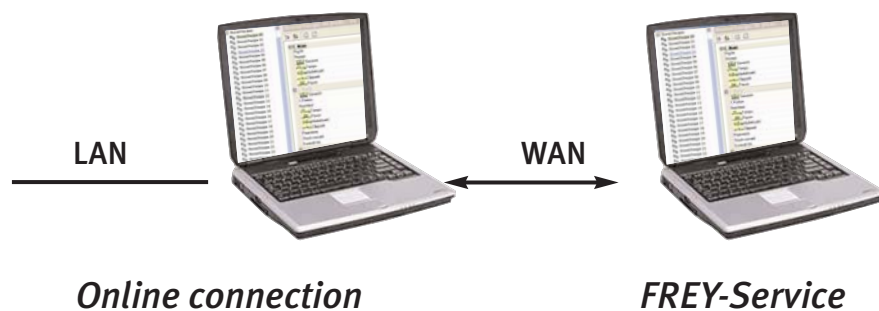



TC 266/733 offers an inimitable variety of functions.

## Survey of functions:

### Weight input

can be chosen between 0,1 and 100.000 g.  
(from 0,0 - 999,9 g in 0,1 g steps)

**Number of links** from 0 - 9,9 turns

### Clipping time

**Preselection of pauses** for portioning and linking

**Normal and continuous operation**

**Filling programs with table of contents**

**Programs for cooked sausages**

**Service- and maintenance programs**

**Diagnosis programs**

**Counter of quantity and pieces, pre-selection of pieces**

**Twist delay / twist advance of the linker**

**1st portion makeweight**

### Speed control

infinitely adjustable also during the filling process

### Digital vacuum control

optionally available is an electronic control valve for the stop of the machine and an automatic cleaning of the vacuum pump

**Automatic pressure regulation and torque control**

**Electric pulse control for automatic clipping machines**

**Relieve/sucking back mechanism**

**Activation of CL- and CLPS- line**

**Control of the Pattyformer PF130**

**Different languages adjustable**

**Different backgrounds adjustable**

**Program administration with protection**

**Software update per USB - stick**

**Interfaces: USB, Ethernet**

**10/100 Mbps**

**Online connection with your office PC**

**via TCP/IP connectivity**

**Visualizing of filling and linking process**

**Logbuch of the filling process and errors**

## Interface/connection

The filling machines will be integrated in your computer network. By this way you control your filling machines from your office. The connection is done via the Freeware Software VNC which offers a full functional diversity per telecontrol. You can do all settings on the machines from your office. Loading or storing of filling programs. The starting and stopping function of the machine however can only be done with the operating bar.

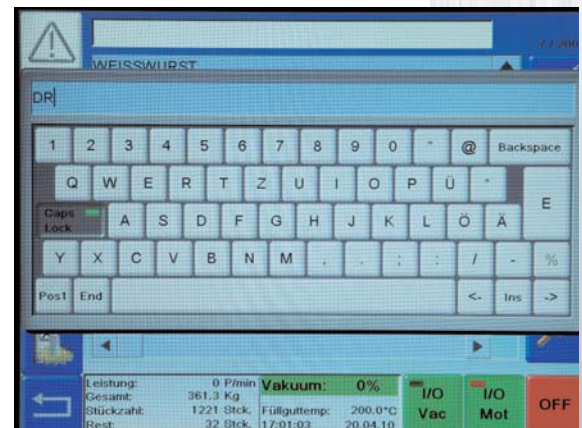



DHGN2 + DA2012

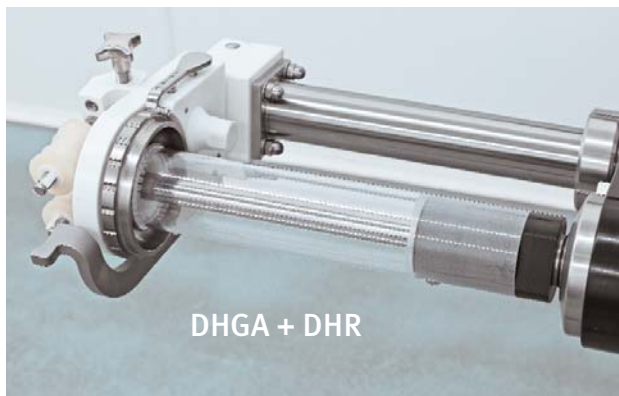

DHGA + DHR



DHG38

## Casing holder devices

### DHGN2

Casing holder devices are available as accessory for FREY-vacuum stuffers. They make the filling process faster and easier. The casing holder DHGN2 is especially designed for natural casings. Furthermore, we offer pneumatic casing spoolers (DA2012). They save time to increase the productivity of the filling station

### DHGA

Compared with the DHGN2 the DHGA is additionally equipped with a ceramic bearing with support for the casing holder tube (DHR) and the roller kit (ROKI). The casing holder device can also be used for collagen and cellulose casings. The DHGA ensures a continuous advance of the casing during the linking process.

The DHGN2 and DHGA are maintenance-free because no drive is necessary.

With the help of our casing holder devices you always get tight and solid sausages at maximum filling speed. The casing holder device is easy to assemble and can be tilted sideways together with the linking gear.

The casing tension is infinitely adjustable.

### DHG38

The DHG38 with own drive is especially suitable for big calibers.

## Services

are nowadays more and more important.

The reliability of our demonstrators and technicians stands for the high quality of FREY products.

Our stuffers are well-thought out even in the smallest details. They are well-known for their long service life

Our trained staff gives you also advice by telephone, fax or email in order to help you immediately.







Techn. data F-Line:	F100	F103	F160	F163
Capacity of the filling hopper:	25/90 liters	25/90 liters	160 liters	160 liters
Maximum filling performance:	3.600 kg/h	3.000 kg/h	3.600 kg/h	3.000kg/h
Filling pressure up to max:	40 bar	55 bar	40 bar	55 bar
Capacity of the chambers:	82 g	82 g	82 g	82 g
Number of wings:	14	14	14	14
Portioning range:	5-100.000 g	5-100.000 g	5-100.000 g	5-100.000 g
Voltage / Tension:	400V/50Hz	400V/50Hz	400V/50Hz	400V/50Hz
Rotor system drive :	Servo	Servo	Servo	Servo
Stirrer drive:	gear drive	gear drive	gear drive	gear drive
Control type:	TC 266/733	TC 266/733	TC 733	TC 733
WS Food standard interface:	serial	serial	serial	serial
Total connected load max.:	8,75 KW	8,75 Kw	9,85 Kw	9,85 Kw
Suction power of the vacuum pump:	21 cbm/h	21 cbm/h	21 cbm/h	21 cbm/h
Machine weight (net)*:	650 kg	650 kg	885 kg	885 kg
Portioning speed max:	600 port/min.	600 port/min.	600 port/min.	600 port/min.

Techn. data F-Line:	F190	F193	F200
Capacity of the filling hopper:	250 liters	250 liters	250 liters
Maximum filling performance:	3.600 kg/h	3.000 kg/h	4.800 kg/h
Filling pressure up to max:	40 bar	55 bar	40 bar
Capacity of the chambers:	82 g	82 g	82 g
Number of wings:	14	14	14
Portioning range:	5-100.000 g	5-100.000 g	5-100.000 g
Voltage / Tension:	400V/50Hz	400V/50Hz	400V/50Hz
Rotor system drive :	Servo	Servo	Servo
Stirrer drive:	gear drive	gear drive	gear drive
Control type:	TC 733	TC 733	TC 733
WS Food standard interface:	serial	serial	serial
Total connected load max.:	9,85 KW	9,85 Kw	11,75 Kw
Suction power of the vacuum pump:	21 cbm/h	21 cbm/h	21 cbm/h
Machine weight (net):	925 kg	925 kg	930 kg
Portioning speed max:	600 port/min.	600 port/min.	600 port/min.



Servo drive of the linker optionally available (necessary for WK130)  
 Special voltage on request (increase of weight upto 60 kg).  
 Optionally available: electronic control valve for the vacuum system

Technical modifications are subject to change.

**Accessories:** Rotor extractor, outlet cleaner, operating instructions, counter screw, accessories holder

Filling tubes Flange 73: 12/24/30/42 mm Flange 35: 14/20 mm

### Special accessories

In order to come up to your product diversity, you can receive special filling tubes or other additional equipment from us, individually made for you. On the Frey accessories trolley all accessories find their place. We would be pleased to inform you. Please call or write us.



# F-Line F100/103 F160/F163 F-Line F190/193 F200

## Dimensions

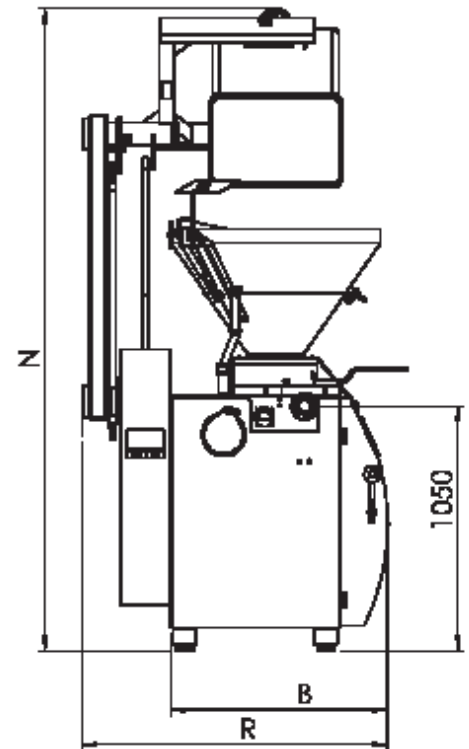
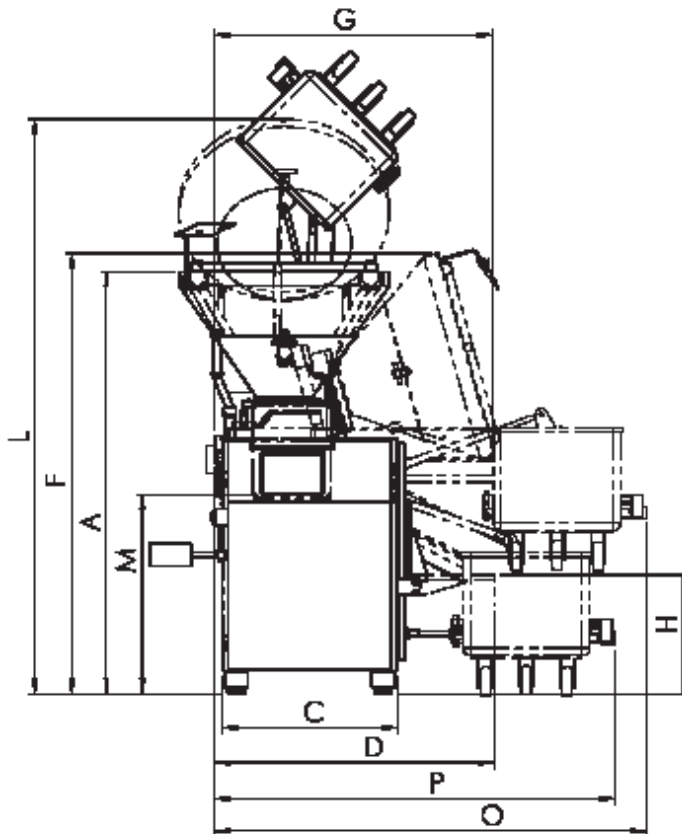

Maß	F100/F103 Hopper 100l	F160/F163 Hopper 160l	F160/F163 Hopper 40/160l	F190/F193 F200 Hopper 250l
A	1720	1820	1810	1920
B	930	930	930	930
C	750	750	750	850
D	1240	1240	1240	1340
F	1820	1930	1890	2070
G	1110	1230	1192	1360
H	490	490	490	760
L	2270	X	2470	X
M	860	860	860	860
<b>With lifting device</b>				
N	X	2770	2770	2950
O	X	1880	1880	2070
P	X	1720	1720	2400
R	X	1310	1310	1330



**Heinrich Frey  
Maschinenbau GmbH**

Fischerstr. 20  
D-89542 Herbrechtingen  
Germany

Phone: +49 7324 172 0

Fax: +49 7324 172 44

Internet: [www.frey-maschinenbau.de](http://www.frey-maschinenbau.de)

Email: [info@frey-maschinenbau.de](mailto:info@frey-maschinenbau.de)